

SR320 THRU SR3200



Schottky Barrier Rectifiers

Reverse Voltage: 20 to 200 Volts

Forward Current: 3.0 Ampere

RoHS Device
Halogen Free



Features

- Axial lead type devices for through hole design.
- Low power loss, high efficiency.
- High current capability, Low forward voltage drop.
- High surge capability.
- Guard ring for overvoltage protection.
- Ultra high-speed switching.
- Silicon epitaxial planar chip, metal silicon junction.
- Lead-free part meets environmental standards of MIL-STD-19500/228

Mechanical Data

- Case: Molded plastic, DO-201AD/DO-27
- Epoxy: UL94V-0 rate flame retardant.
- Lead: Axial lead, solderable per MIL-STD-202, Method 208 guaranteed.
- Polarity: color band denoted cathode end.
- Weight: 1.10 grams(approx.).

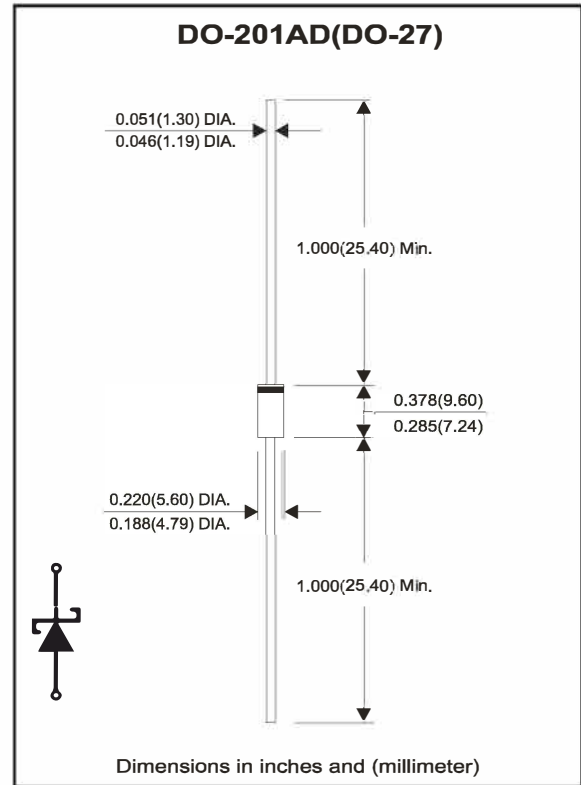

Maximum Ratings and Electrical Characteristics

Ratings at $T_a=25^{\circ}\text{C}$ unless otherwise noted.
Single phase, half wave, 60Hz, resistive or inductive loaded.
For capacitive load, derate current by 20% .

Parameter	Symbol	SR320	SR340	SR360	SR3100	SR3150	SR3200	Unit
Maximum repetitive peak reverse voltage	V_{RRM}	20	40	60	100	150	200	V
Maximum RMS voltage	V_{RMS}	14	28	42	70	105	140	V
Maximum DC blocking voltage	V_{DC}	20	40	60	100	150	200	V
Maximum forward voltage @3A, $T_A=25^{\circ}\text{C}$	V_F	0.45	0.50	0.70	0.81	0.87	0.90	V
Operating junction temperature range	T_J	-50 ~ +150				-50 ~ +175		$^{\circ}\text{C}$

Parameter	Conditions	Symbol	MIN.	TYP.	MAX.	Unit
Forward rectified current	see Fig.1	I_o			3.0	A
Forward surge current	8.3ms single half sine-wave superimposed on rate load (JEDEC method)	I_{FSM}			70	A
Reverse current	$V_R = V_{RRM}$ $T_A=25^{\circ}\text{C}$	I_R			0.5	mA
	$V_R = V_{RRM}$ $T_A=100^{\circ}\text{C}$	I_R			20	mA
Thermal resistance	Junction to ambient	$R_{\theta JA}$		55		$^{\circ}\text{C}/\text{W}$
Diode junction capacitance	f=1MHz and applied 4V DC reverse Voltage	C_J		250		pF
Storage temperature range		T_{STG}	-55		+175	$^{\circ}\text{C}$

Company reserves the right to improve product design , functions and reliability without notice.

Rev.1.0

Rating and Characteristic Curves

Fig.1 - Typical Forward Current Derating Curve

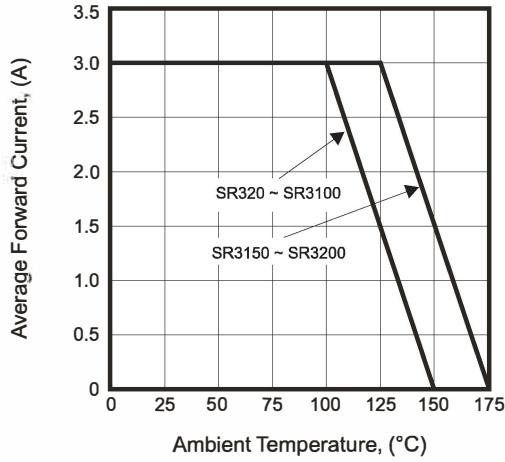

Fig.2 - Typical Forward Characteristics

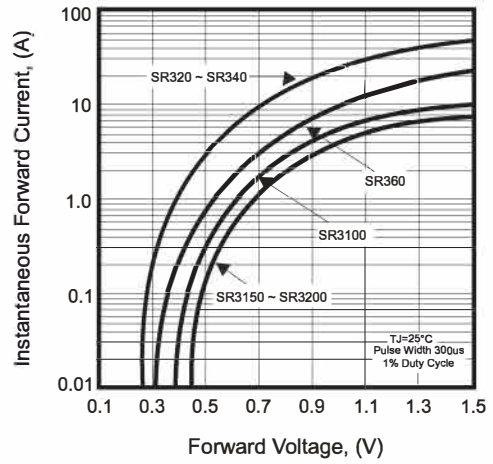

Fig.3 - Maximum Non-repetitive Forward Surge Current

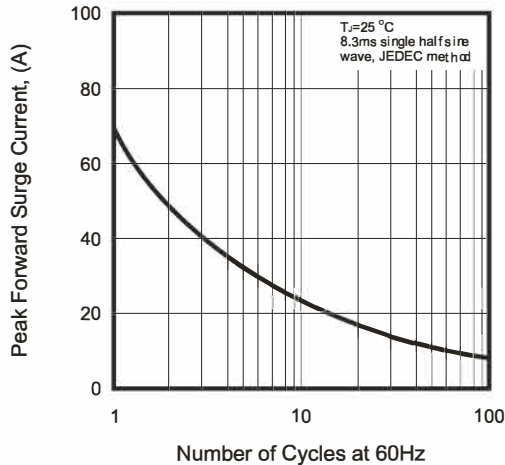

Fig.4 - Typical Junction Capacitance

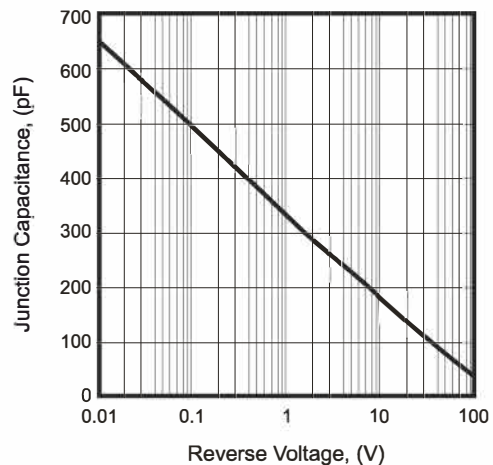
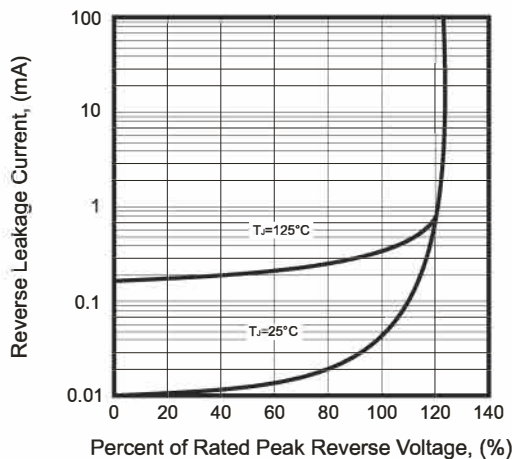

Fig.5 - Typical Reverse Characteristics



SR320 THRU SR3200



Taping Specification For Axial Lead Diodes

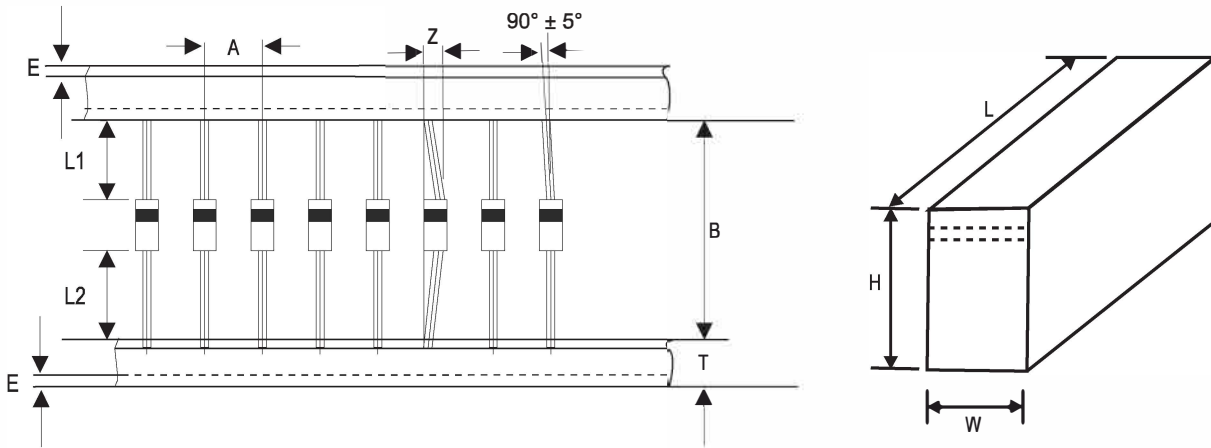

DO-27	SYMBOL	A	B	Z	T	E
	(mm)	10.00 ± 0.50	52.40 (max)	1.60 (max)	6.00 ± 0.40	3.00 (max)
	(inch)	0.394 ± 0.020	2.063 (max)	0.062 (max)	0.236 ± 0.016	0.118 (max)

DO-27	SYMBOL	L1-L2	L	W	H
	(mm)	1.00(max)	260 ± 5.00	75 ± 5.00	145 ± 5.00
	(inch)	0.039(max)	10.236 ± 0.197	2.953 ± 0.197	5.709 ± 0.197

Marking Code

Part Number	Marking Code
SR320	SR320
SR340	SR340
SR360	SR360
SR3100	SR3100
SR3150	SR3150
SR3200	SR3200

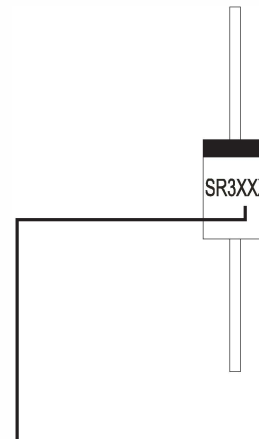

XX / XXX = Product type marking code

Standard Packaging

Case Type	AMMO PACK	
	BOX (pcs)	CARTON (pcs)
DO-27	1,250	12,500